

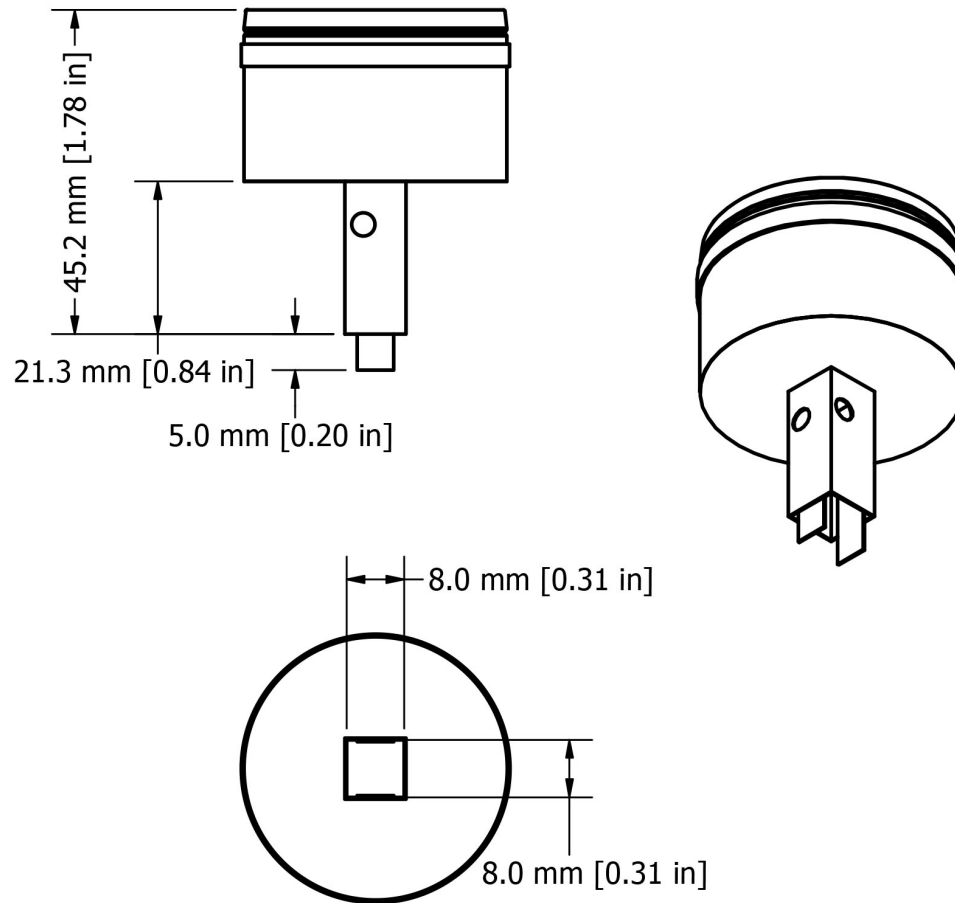

Made in the  
United States of America  
with Globally Sourced  
Materials



*All dimensions have a tolerance of  $\pm 1.00$  mm unless otherwise specified.*

**REFLOW NOZZLE, WITH TWEEZERS, 8.0MM X 8.0MM**

**APR**

3651 WALNUT AVENUE, CHINO, CA 91710  
PHONE: (909) 664-9980  
WEBSITE: [APR-Rework.com](http://APR-Rework.com)

**DRAWING  
NUMBER**  
NZA-TW-080-080

**DATE:**  
March  
2020