

Made in the
United States of America
with Globally Sourced
Materials

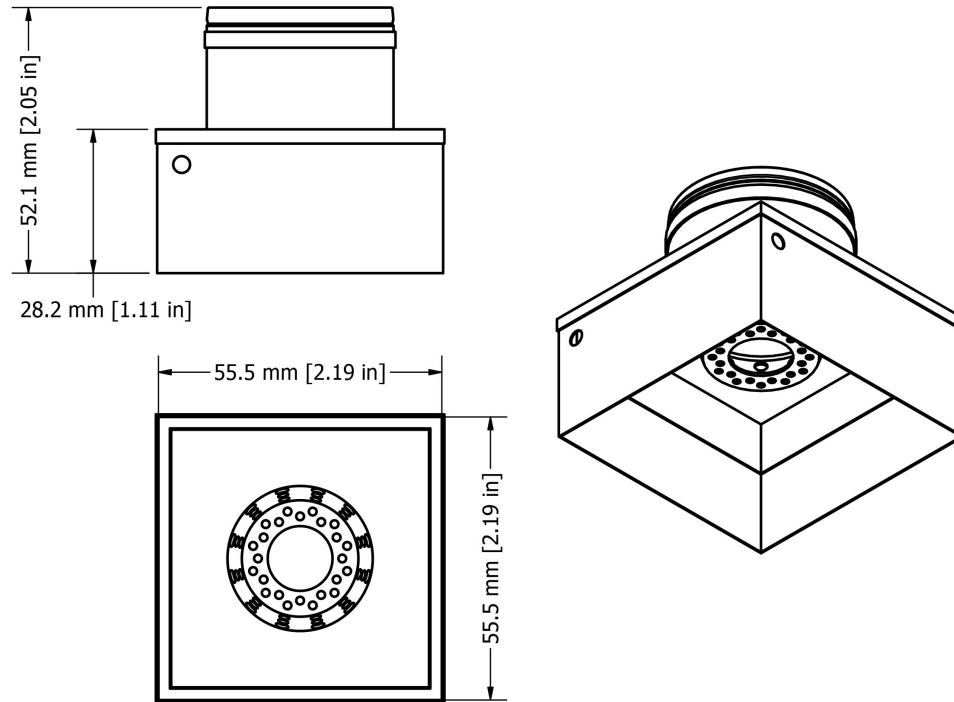

All dimensions have a tolerance of ± 1.00 mm unless otherwise specified.

REFLOW NOZZLE, CGA, 55.5MM X 55.5MM

3651 WALNUT AVENUE, CHINO, CA 91710
PHONE: (909) 664-9980
WEBSITE: APR-Rework.com

**DRAWING
NUMBER**
NZA-555-555-CGA

DATE:
March
2020

APR