

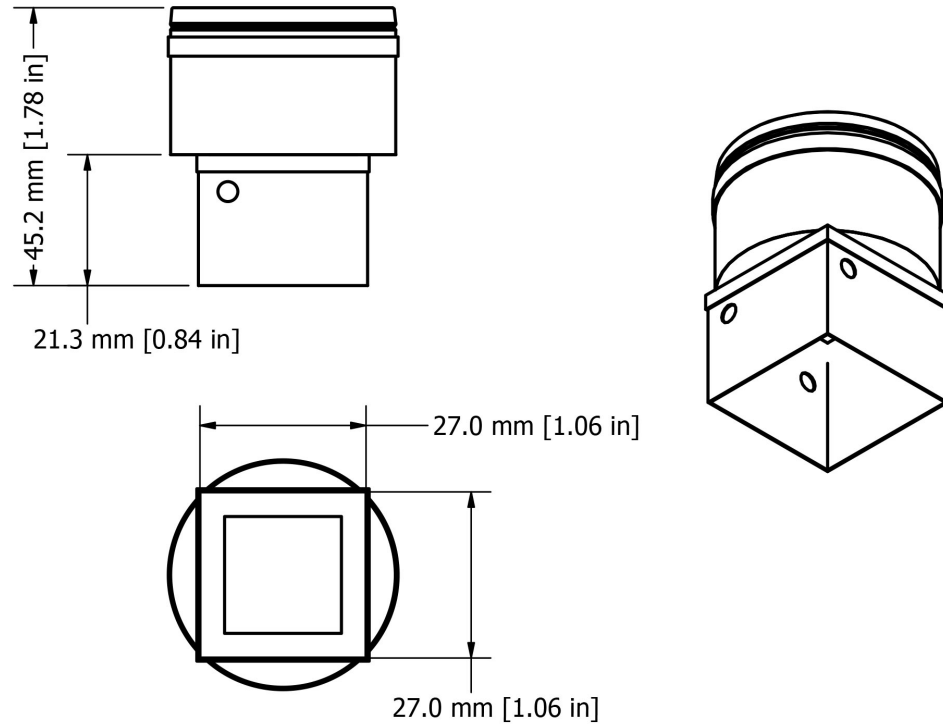

Made in the
United States of America
with Globally Sourced
Materials



All dimensions have a tolerance of ± 1.00 mm unless otherwise specified.

REFLOW NOZZLE, 27.0MM X 27.0MM

3651 WALNUT AVENUE, CHINO, CA 91710
PHONE: (909) 664-9980
WEBSITE: APR-Rework.com

**DRAWING
NUMBER**
NZA-270-270

DATE:
January
2020

APR