

Assembly Instructions for - 38804

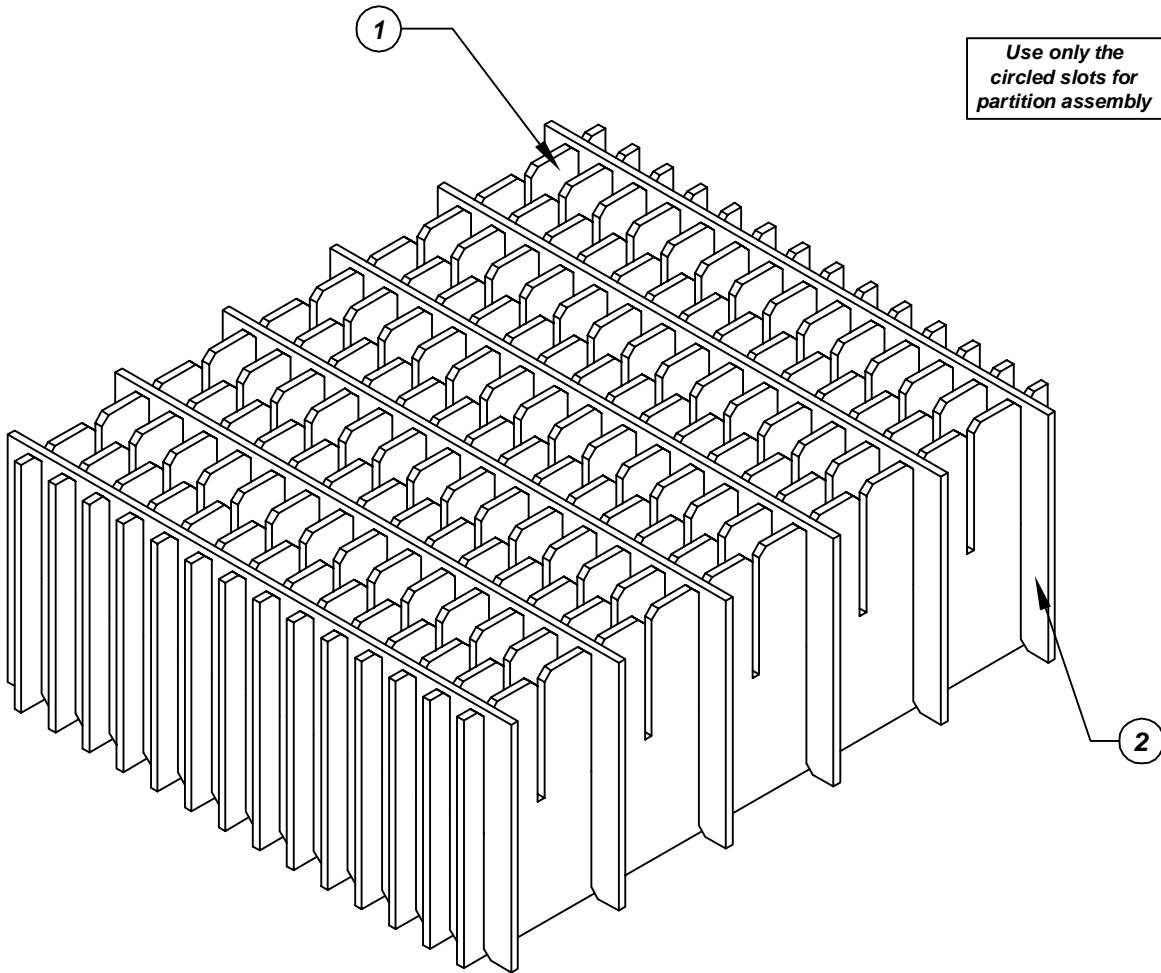

Use only the circled slots for partition assembly

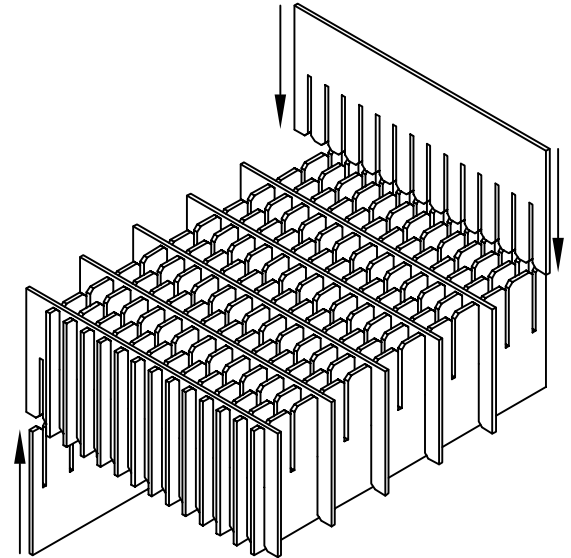
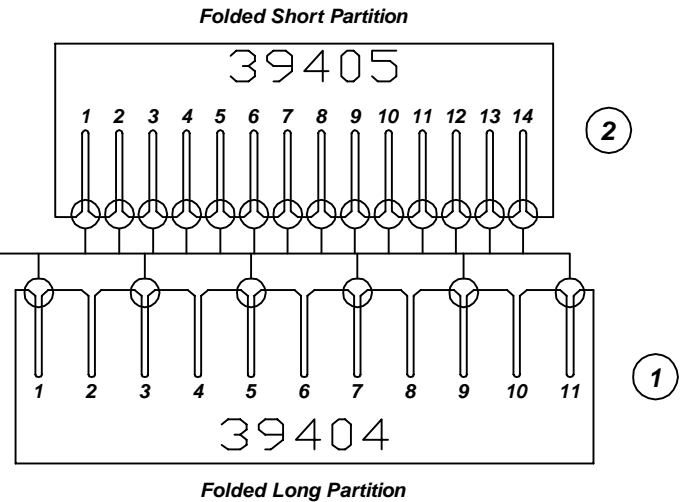

Made in America

F/N ①	Part # 39404	Dimensions: 16-3/16" x 21-3/4"	Description: Adjustable Long Partition	Qty: 14
F/N ②	Part # 39405	Dimensions: 16-3/16" x 18-3/4"	Description: Adjustable Short Partition	Qty: 6

38804 - 75 Cell Inplant Handler Cell Size - 8" x 3-3/4" x 1"

Notes:
For use with the following storage container & lid:
37532 - Storage Container
37557 - Lid

PROTEKTIVE PAK
13520 MONTE VISTA AVENUE, CHINO, CA 91710
PHONE (909) 627-2578, FAX (909) 363-7331
ProtektivePak.com



DRAWING NUMBER
IPH-38804

DATE
Dec. 2007