

# Assembly Instructions for - 37384

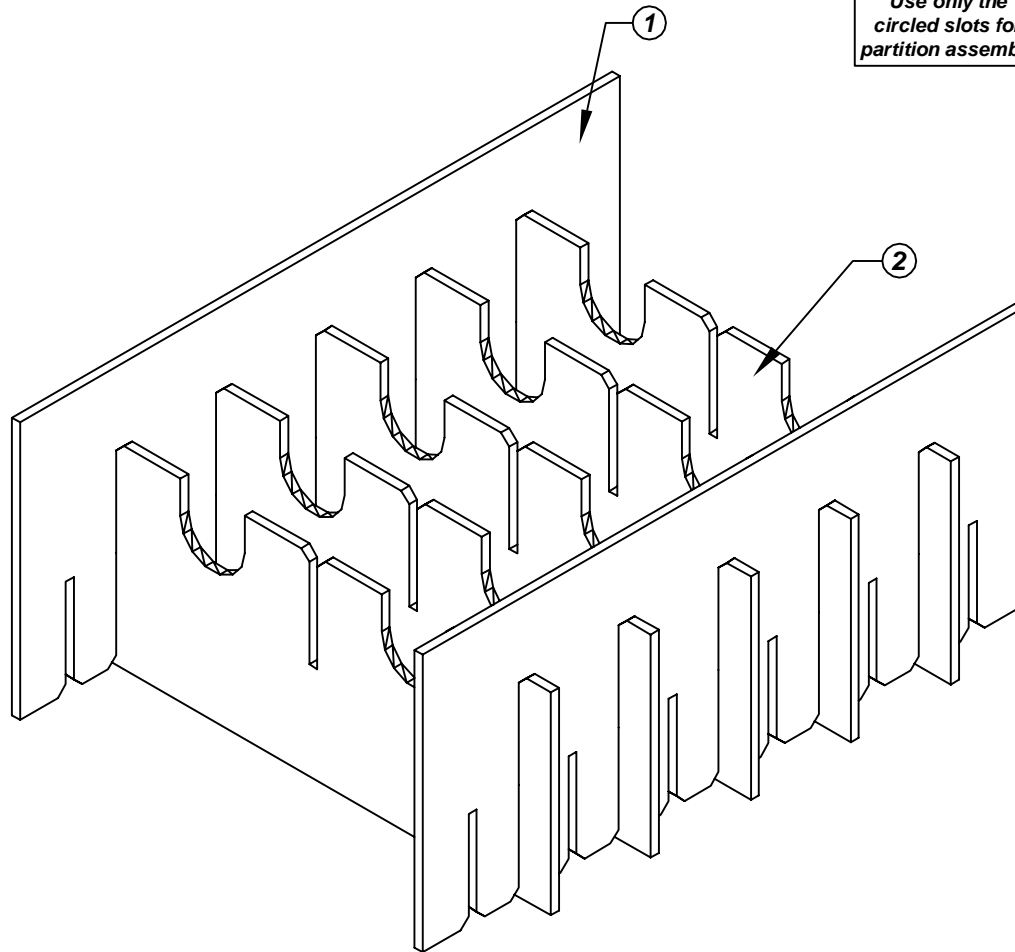

Use only the circled slots for partition assembly

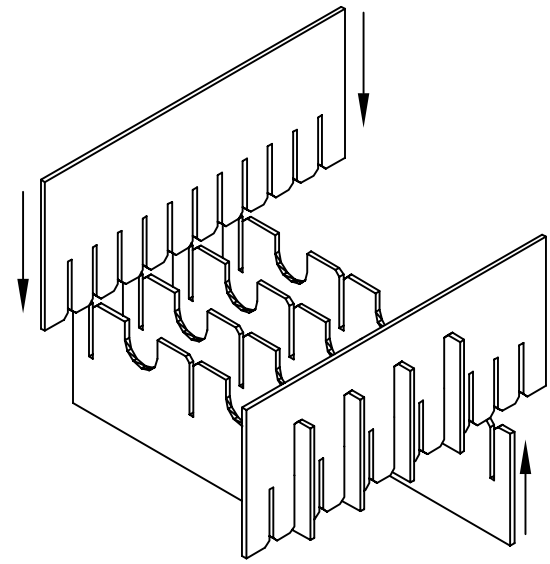
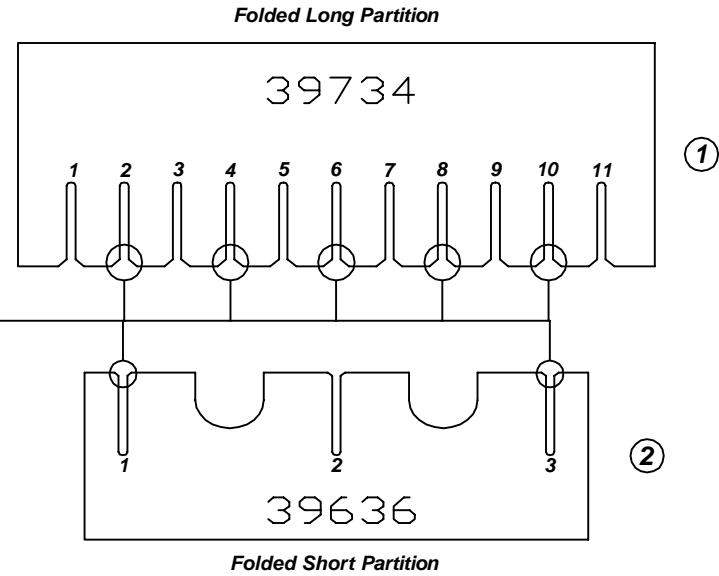

Made in America

F/N ①	Part # 39734	Dimensions: 16-1/4" x 18-5/8"	Description: 468-HLP-12 Long Partition	Qty: 2
F/N ②	Part # 39636	Dimensions: 12" x 14-3/4"	Description: 406/468-HSP Short Partition	Qty: 5

## 37384 - 6 Cell Inplant Handler Cell Size - 8" x 12-3/4" x 2-7/8"

Notes:  
For use with the following storage container & lid:  
37527 - Storage Container  
37554 - Lid

PROTEKTIVE PAK  
13520 MONTE VISTA AVENUE, CHINO, CA 91710  
PHONE (909) 627-2578, FAX (909) 363-7331  
ProtektivePak.com



DRAWING NUMBER  
**IPH-37384**

DATE  
Nov.  
2007