

Assembly Instructions for - 37303

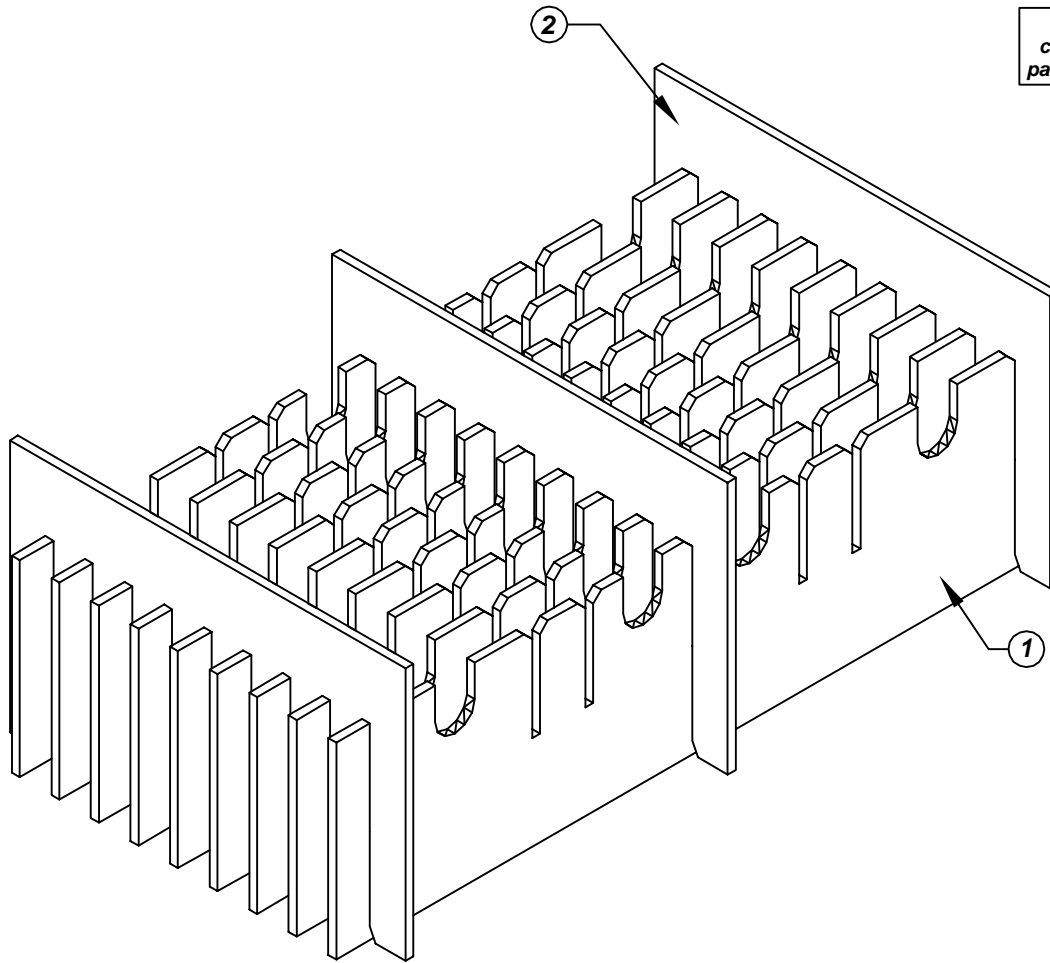

Use only the circled slots for partition assembly

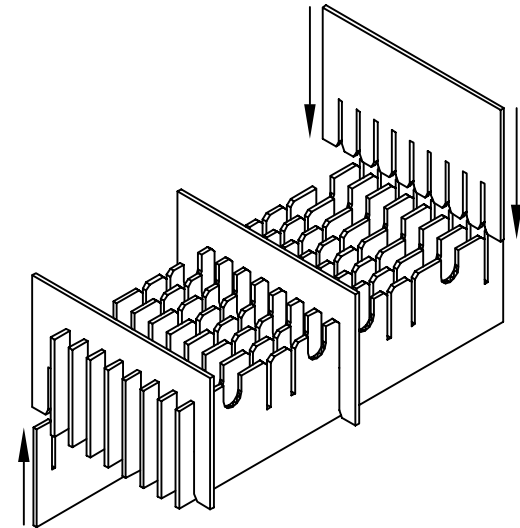
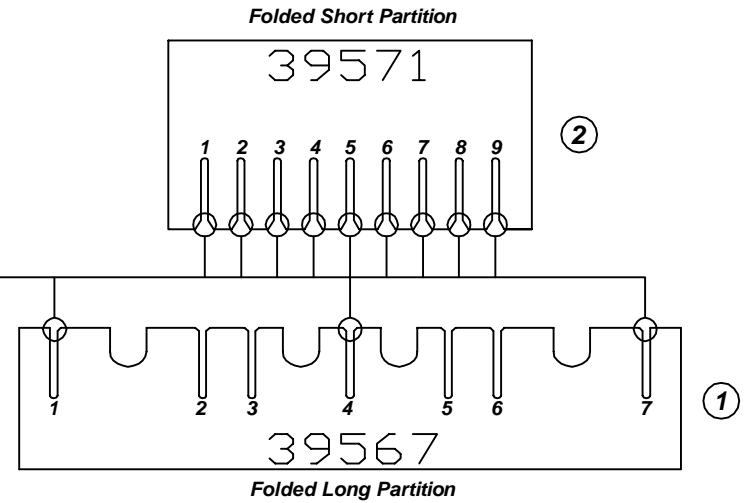

Made in America

F/N ①	Part # 39567	Dimensions: 12-1/8" x 22-3/4"	Description: 448/446-LP Long Partition	Qty: 9
F/N ②	Part # 39571	Dimensions: 16-1/16" x 12-1/2"	Description: 448-SP Short Partition	Qty: 3

37303 - 20 Cell Inplant Handler Cell Size - 8" x 10" x 1"

Notes:
For use with the following storage container & lid:
37517 - Storage Container
37552 - Lid

PROTEKTIVE PAK
13520 MONTE VISTA AVENUE, CHINO, CA 91710
PHONE (909) 627-2578, FAX (909) 363-7331
ProtektivePak.com



DRAWING NUMBER
IPH-37303

DATE
Dec.
2007