

Assembly Instructions for - 37294

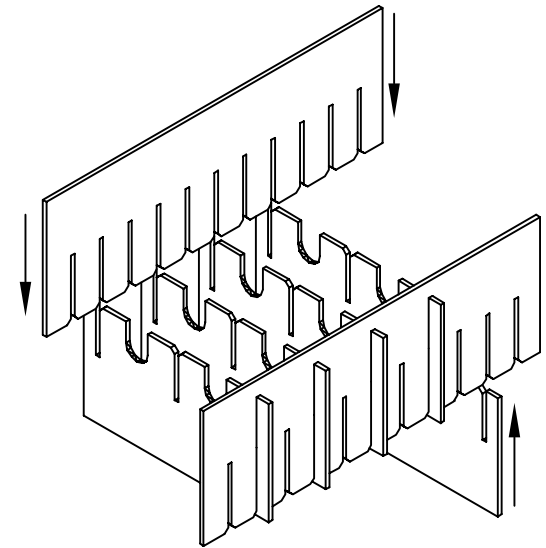
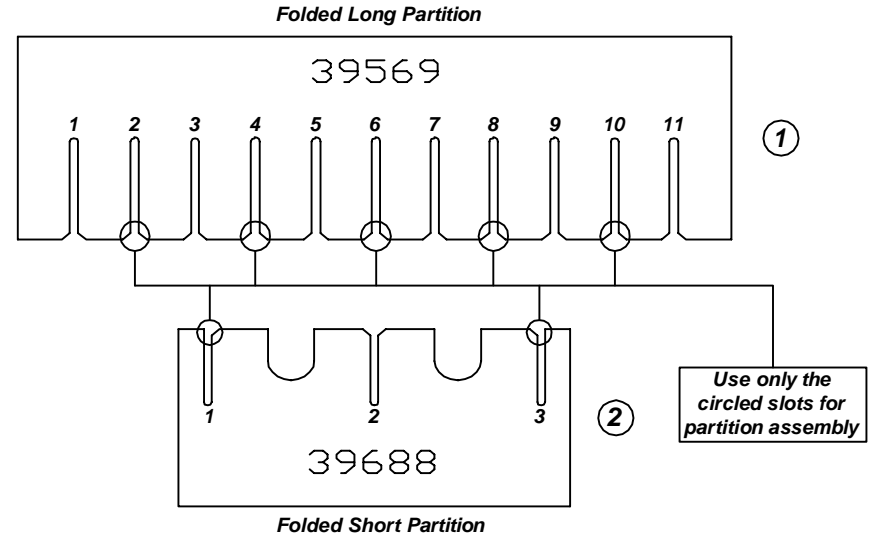
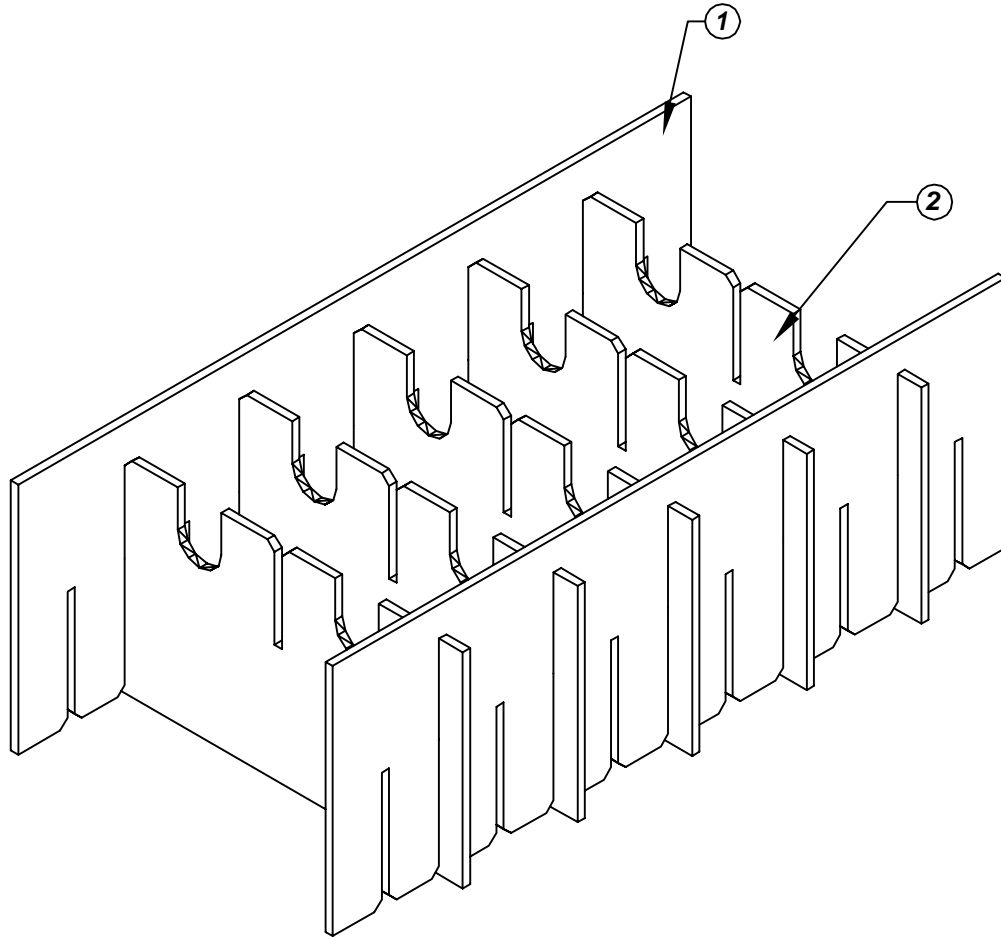

Made in America

F/N ①	Part # 39569	Dimensions: 16-1/4" x 23"	Description: 448-HLP Long Partition	Qty: 2
F/N ②	Part # 39688	Dimensions: 14-1/4" x 12-5/8"	Description: 448-HSP Short Partition	Qty: 5

37294 - 6 Cell Inplant Handler Cell Size - 8" x 10-3/4" x 3-5/8"

Notes:
For use with the following storage container & lid:
37517 - Storage Container
37552 - Lid

PROTEKTIVE PAK
13520 MONTE VISTA AVENUE, CHINO, CA 91710
PHONE (909) 627-2578, FAX (909) 363-7331
ProtectivePak.com



DRAWING NUMBER
IPH-37294

DATE
Nov.
2007