

Assembly Instructions for - 37282

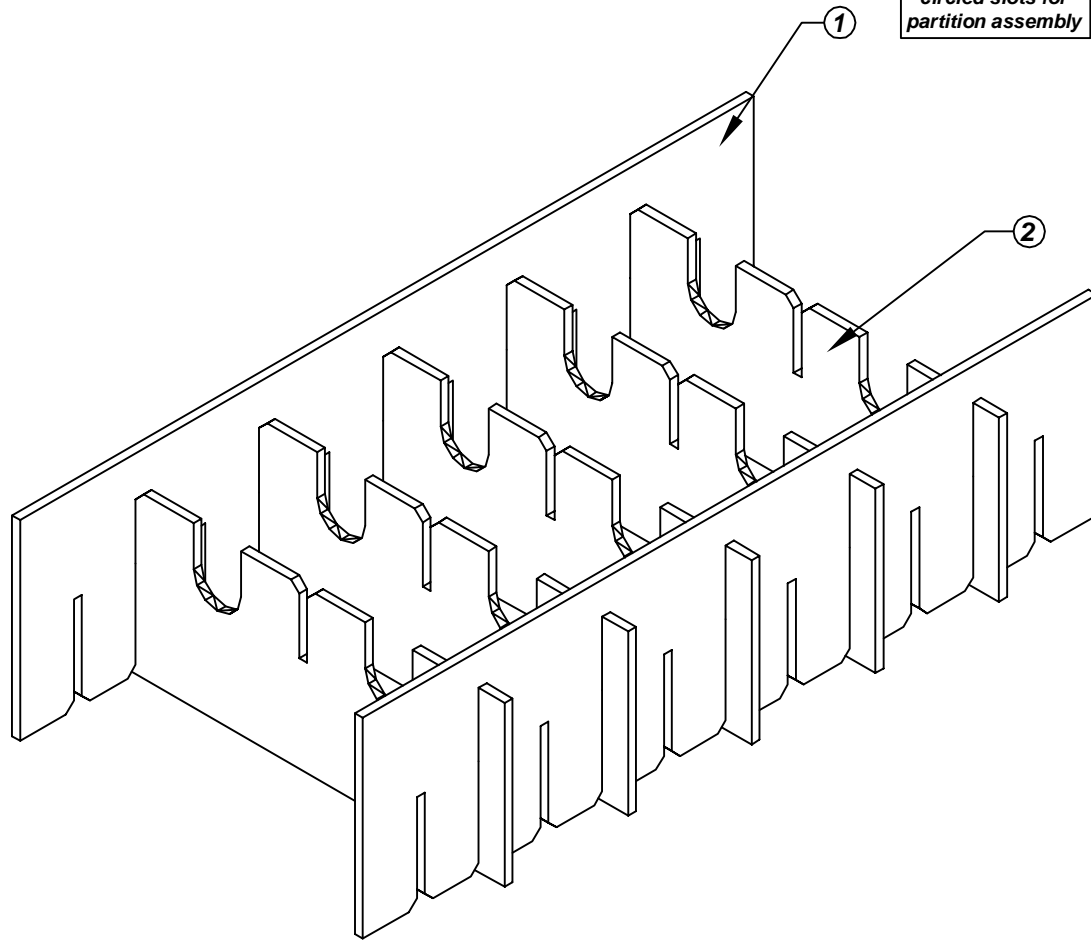

Use only the circled slots for partition assembly

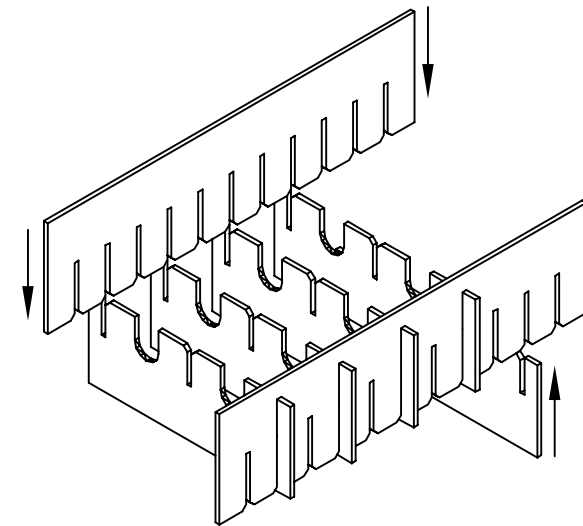
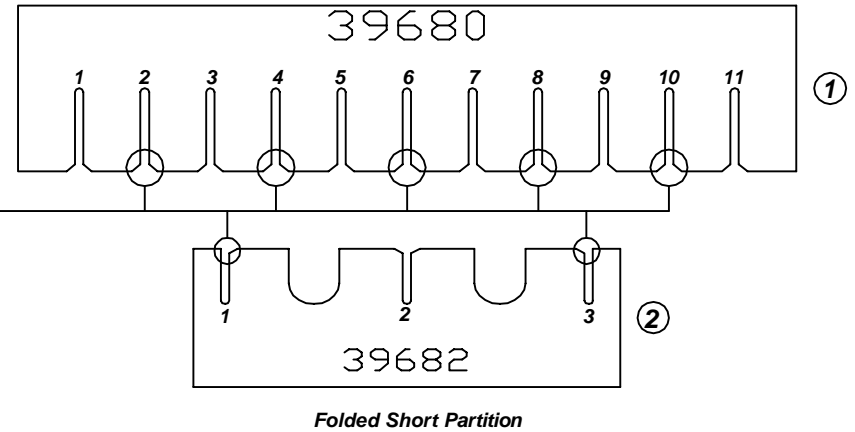

Made in America

F/N ①	Part # 39680	Dimensions: 12-1/4" x 23"	Description: 446-HLP Long Partition	Qty: 2
F/N ②	Part # 39682	Dimensions: 10-1/4" x 12 5/8"	Description: 446-HSP Short Partition	Qty: 5

37282 - 6 Cell Inplant Handler Cell Size - 6" x 10-3/4" x 3-5/8"

Notes:
For use with the following storage container & lid:
37516 - Storage Container
37552 - Lid

PROTEKTIVE PAK
13520 MONTE VISTA AVENUE, CHINO, CA 91710
PHONE (909) 627-2578, FAX (909) 363-7331
ProtectivePak.com

PROTEKTIVE PAK
BURIED CONDUCTIVE LAYER

DRAWING NUMBER
IPH-37282

DATE
Nov.
2007