

# Assembly Instructions for - 37272

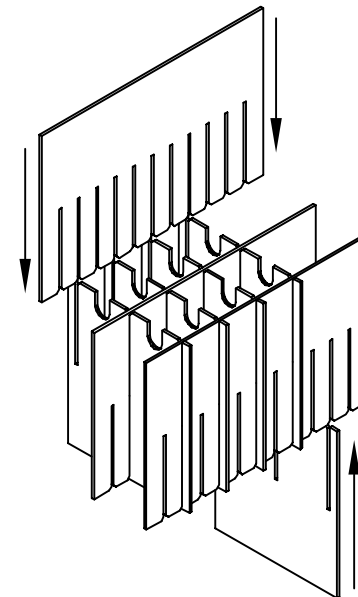
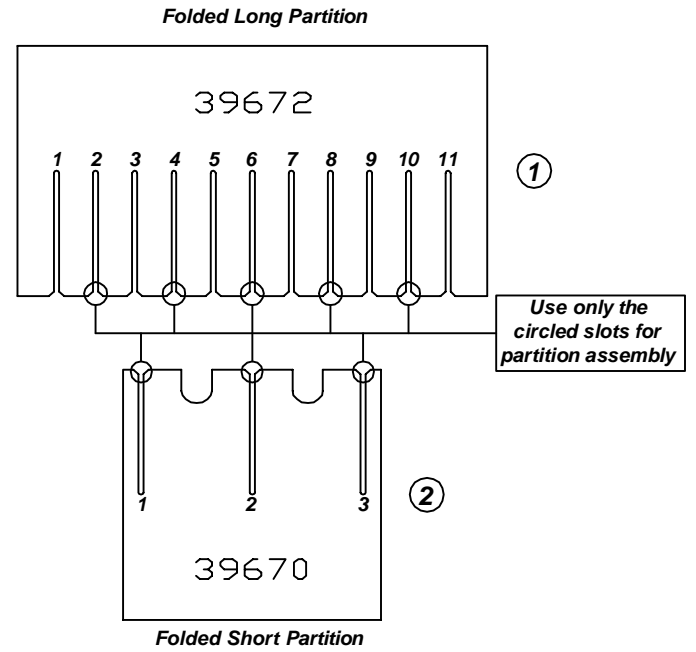
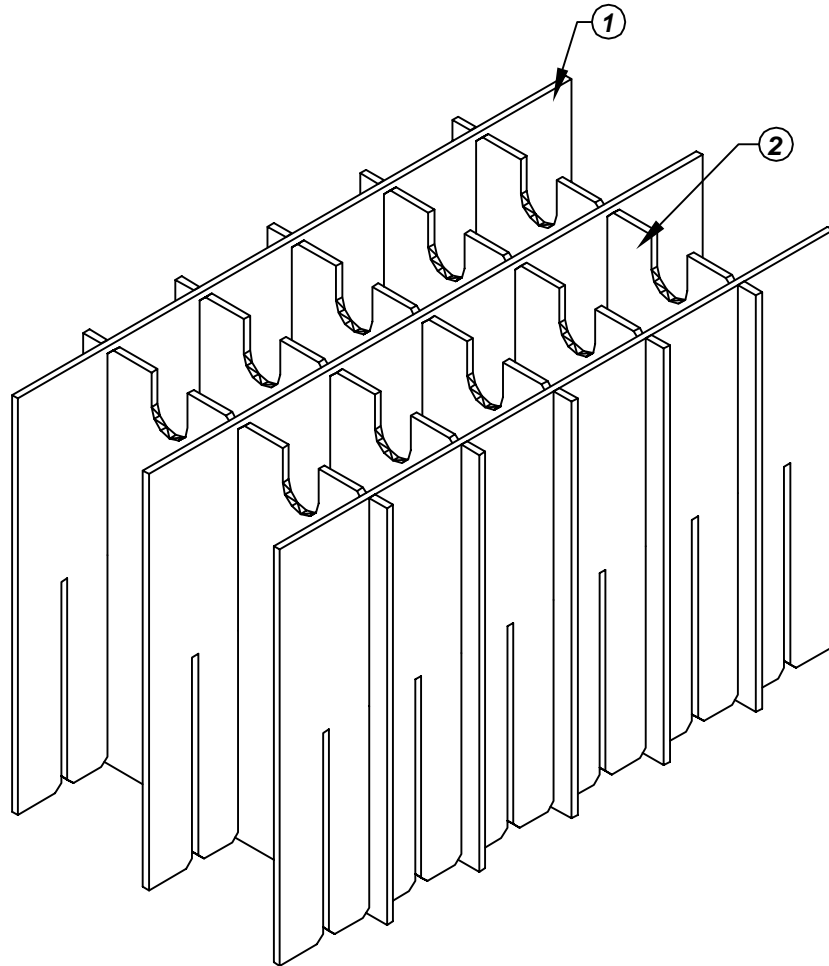

Made in America

F/N ①	Part # 39672	Dimensions: 30-1/4" x 23"	Description: 445-HLP Long Partition	Qty: 3
F/N ②	Part # 39670	Dimensions: 30-1/4" x 12-5/8"	Description: 445/408-HSP Short Partition	Qty: 5

**37272 - 12 Cell Inplant Handler**  
**Cell Size - 15-1/4" x 5-3/16" x 3-5/8"**

Notes:  
 For use with the following storage container & lid:  
 37515 - Storage Container  
 37552 - Lid

PROTEKTIVE PAK  
 13520 MONTE VISTA AVENUE, CHINO, CA 91710  
 PHONE (909) 627-2578, FAX (909) 363-7331  
 ProtectivePak.com

**PROTEKTIVE PAK**  
 BURIED CONDUCTIVE LAYER

DRAWING NUMBER  
**IPH-37272**

DATE  
 Nov.  
 2007