

Assembly Instructions for - 37233

Use only the circled slots for partition assembly

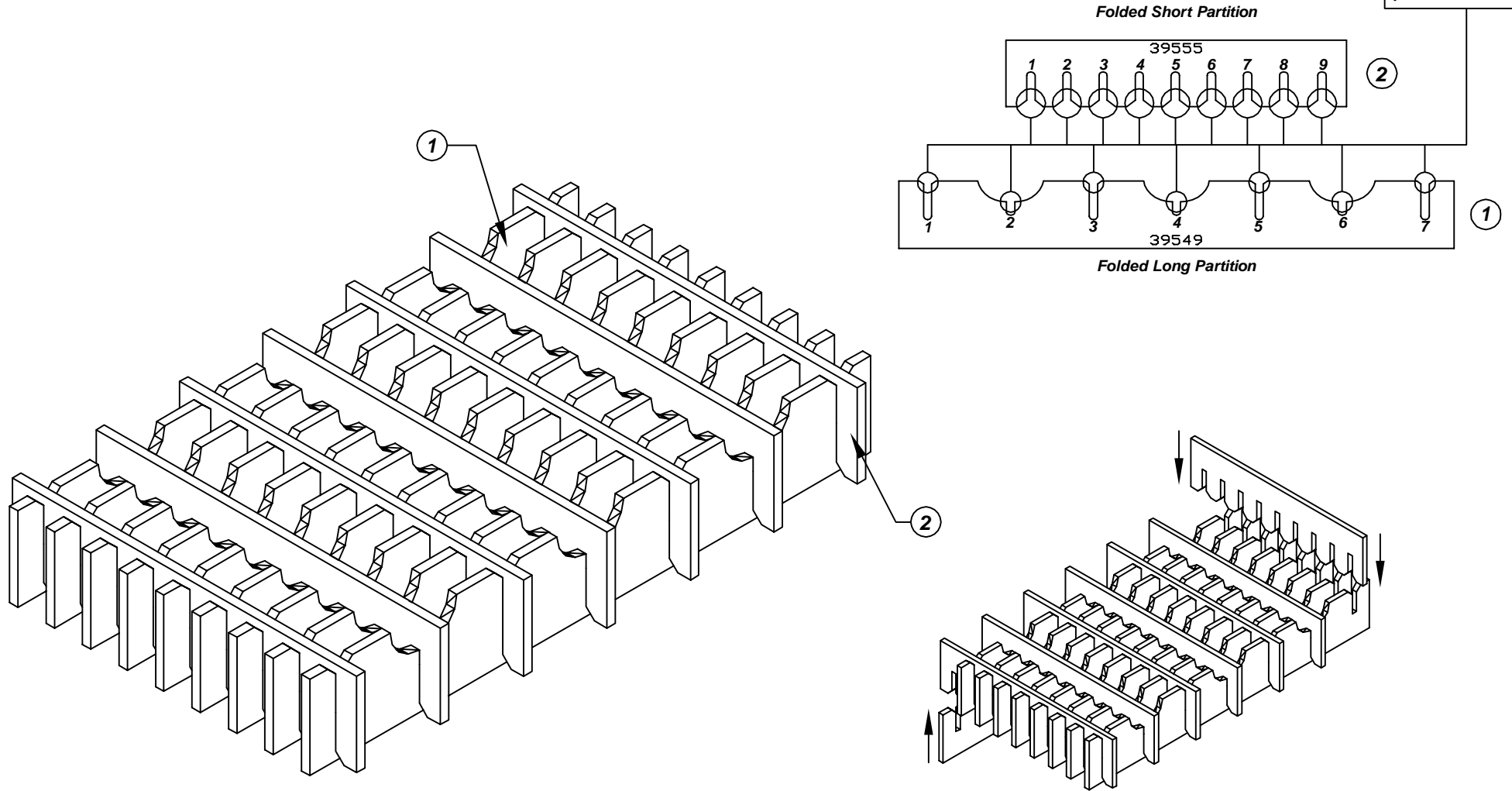

Made in America

F/N ①	Part # 39549	Dimensions: 5-3/16" x 16-13/16"	Description: 411/422-LP Long Partition	Qty: 9
F/N ②	Part # 39555	Dimensions: 5-3/16" x 9-7/8"	Description: 422-SP Short Partition	Qty: 7

37233 - 60 Cell Inplant Handler Cell Size - 2-1/2" x 2-1/4" x 3/4"

Notes:
For use with the following storage container & lid:
37509 - Storage Container
37550 - Lid

PROTEKTIVE PAK
13520 MONTE VISTA AVENUE, CHINO, CA 91710
PHONE (909) 627-2578, FAX (909) 363-7331
ProtektivePak.com



DRAWING NUMBER
IPH-37233

DATE
Nov. 2007