

Assembly Instructions for - 37163

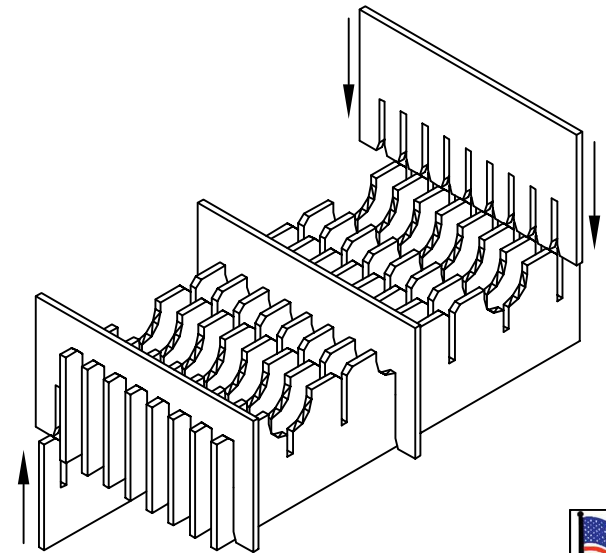
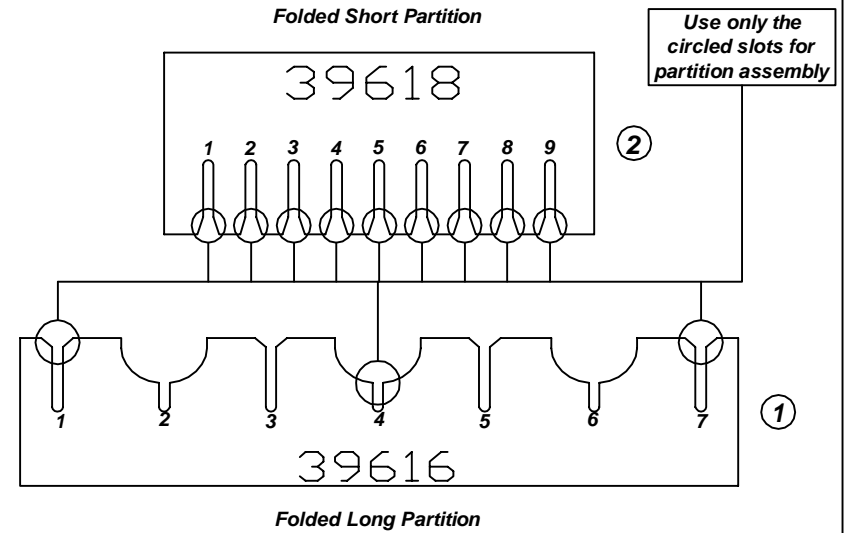
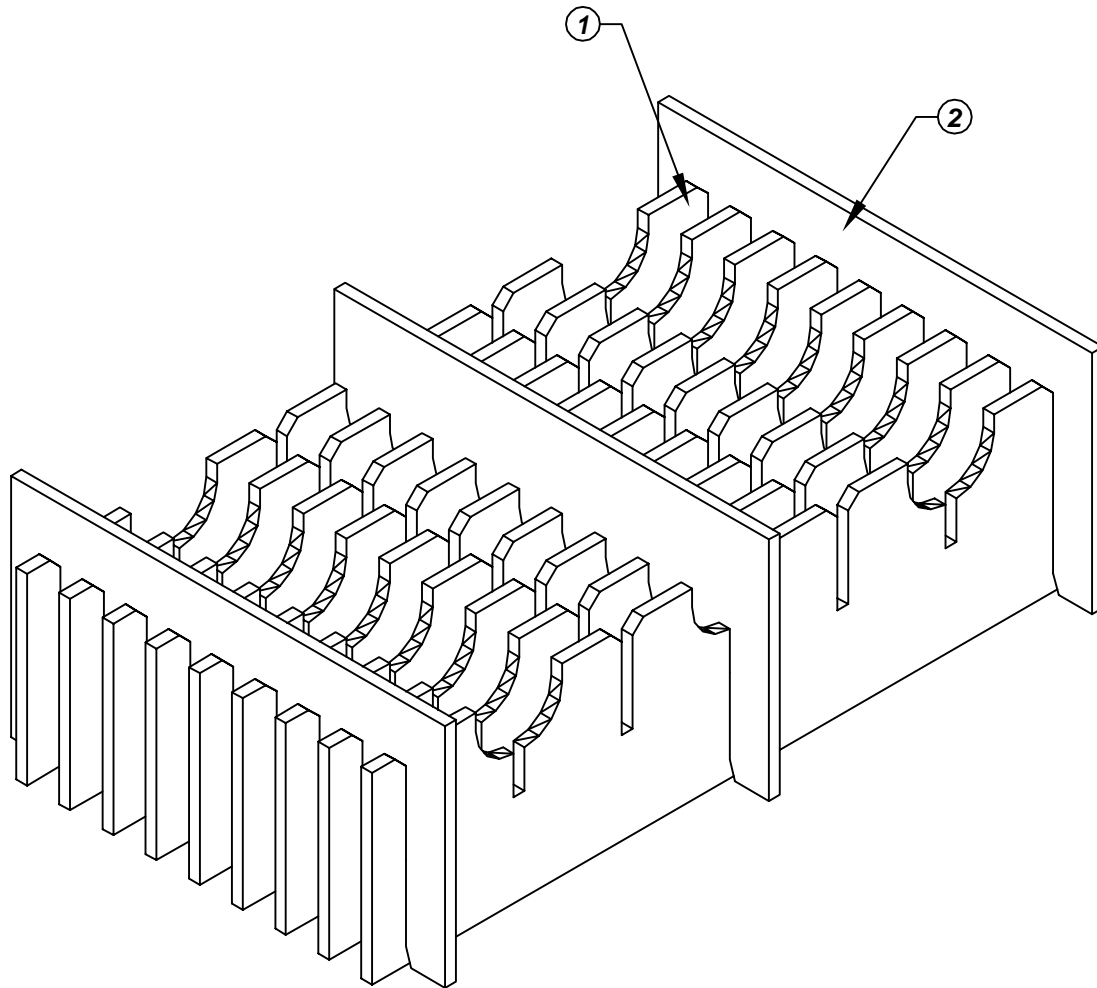

Made in America

F/N ①	Part # 39616	Dimensions: 8-11/16" x 16-13/16"	Description: 401-LP Long Partition	Qty: 9
F/N ②	Part # 39618	Dimensions: 10-11/16" x 10"	Description: 401-SP Short Partition	Qty: 3

Notes:
For use with the following storage container & lid:
37501 - Storage Container
37550 - Lid

PROTEKTIVE PAK
13520 MONTE VISTA AVENUE, CHINO, CA 91710
PHONE (909) 627-2578, FAX (909) 363-7331
ProtektivePak.com

PROTEKTIVE PAK
BURIED CONDUCTIVE LAYER

DRAWING NUMBER
IPH-37163

DATE
Nov.
2007

37163 - 20 Cell Inplant Handler
Cell Size - 5-3/8" x 7-1/4" x 3/4"